

Package contents (parts are not to scale):

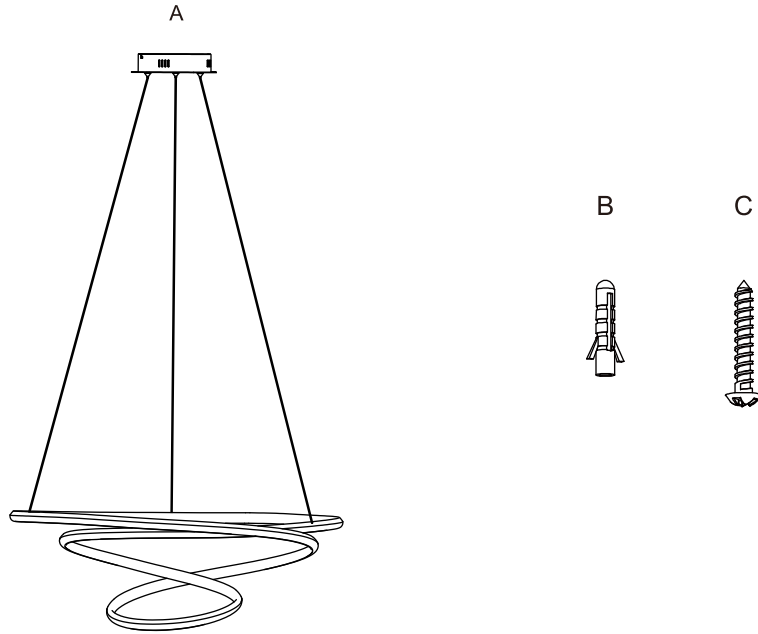

Part	Description	Quantity
A	Fixture body with wire	1
B	Wall expansion particle	2
C	Self-Tapping screw	2

Light source

Max. LED 65W 4130Lumen 3000K (Dimmable)

(Lamp gurantee: 3 years)

Care and Cleaning

EXTERIOR MAINTENANCE

1. To clean the outside of the fixture, use a dry or slightly dampened clean cloth (use clean water, never a solvent) to wipe the surface of the fixture.
2. Do not use any cleaners with chemicals, solvents or harsh abrasives. Use only a dry soft cloth to dust or wipe carefully.

INTERIOR PENDANT

Art Nr. 54804-080-71

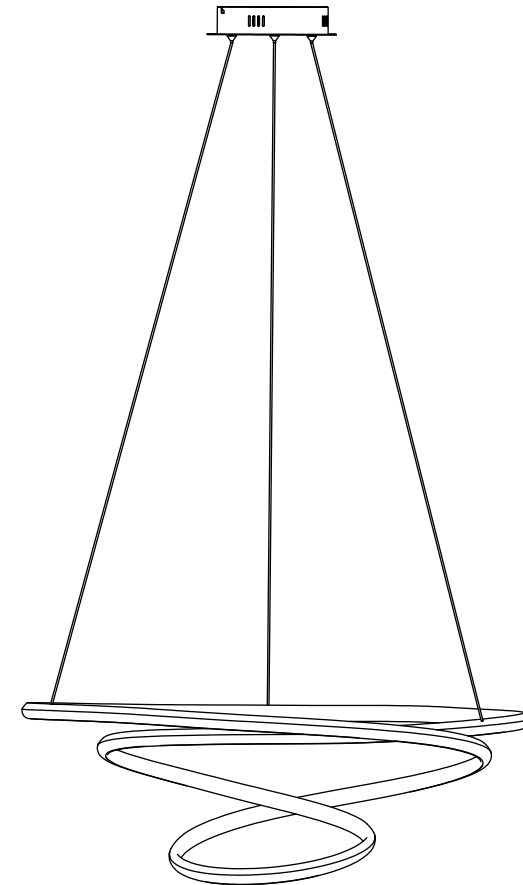

Pre-Installation

PLANNING THE INSTALLATION

Read all instructions before assembly and installation. Before starting installation of the fixture or removal of a previous fixture, disconnect the power by turning off the circuit breaker or by removing the fuse at the fuse box. To avoid damaging this product, assemble it on a soft, non-abrasive surface such as carpet or cardboard.

TOOLS REQUIRED

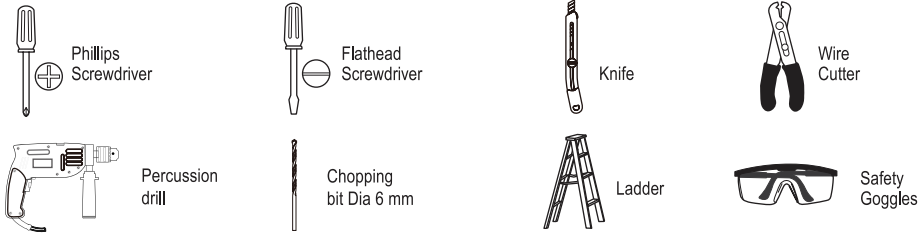

Installation (Make sure to turn off the main power)

Step 1.

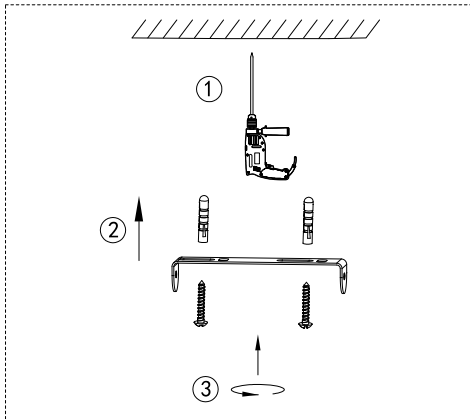

Step 2.

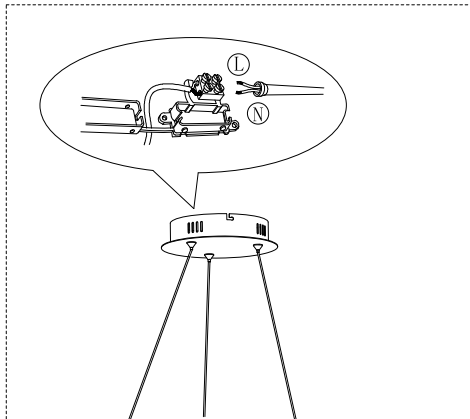

Step 3.

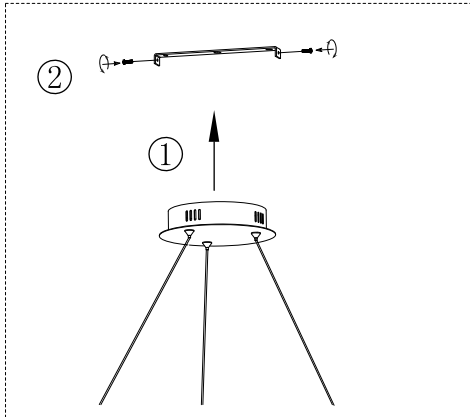

Step 4.

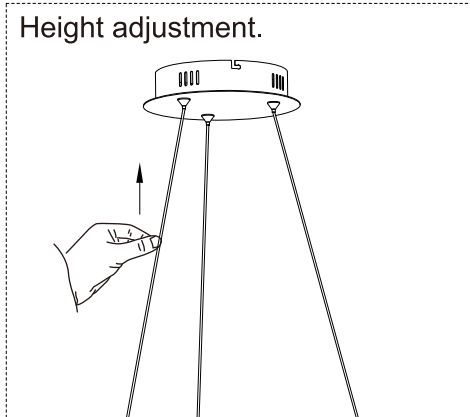

Installation (continued)

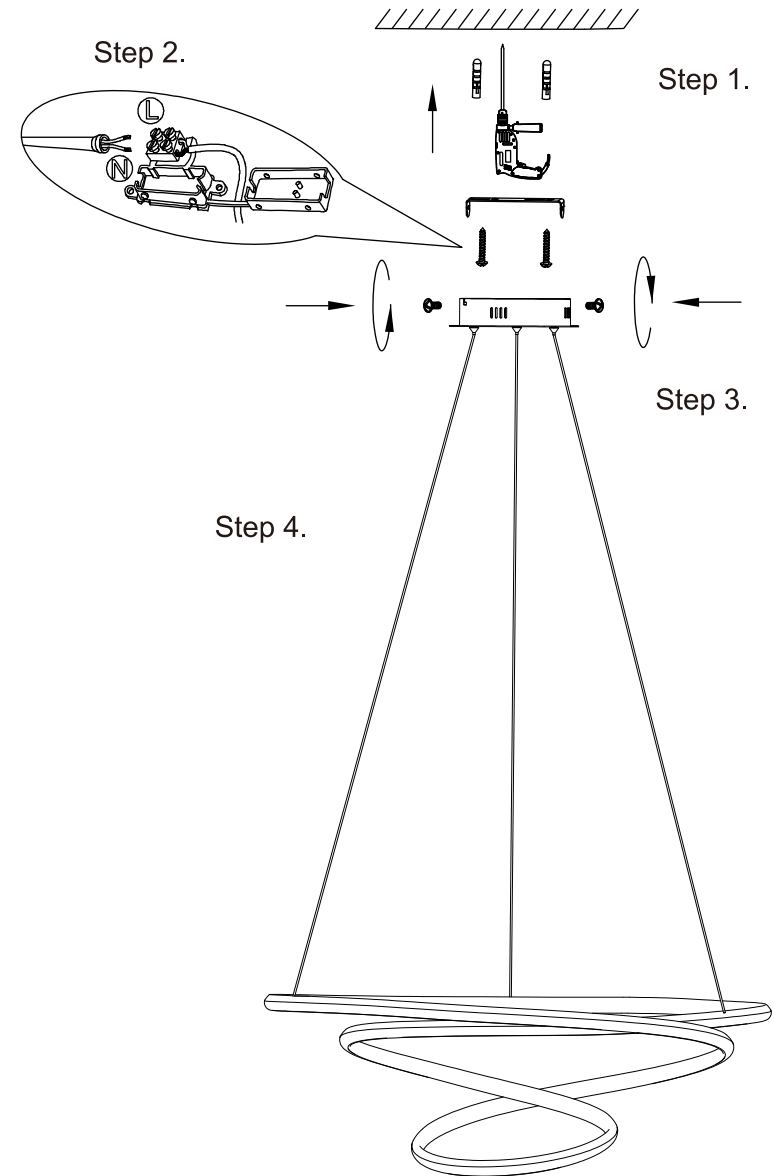

Operation

- Turn on power at the circuit breaker or fuse box.
- Turn the light switch on to activate the fixture.