

Gebruiksaanwijzing
Notice d'emploi
Benutzerhandbuch
User manual
Manual de usuario

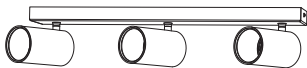

50592/**/P0



50593/**/P0



50591/**/P0

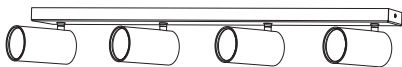

50594/**/P0

PHILIPS

Incl.



50592/**/P0

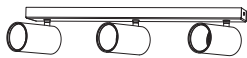

50593/**/P0



50591/**/P0

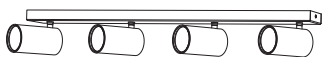

50594/**/P0

Excl.

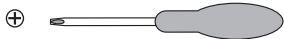
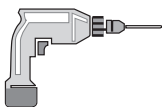

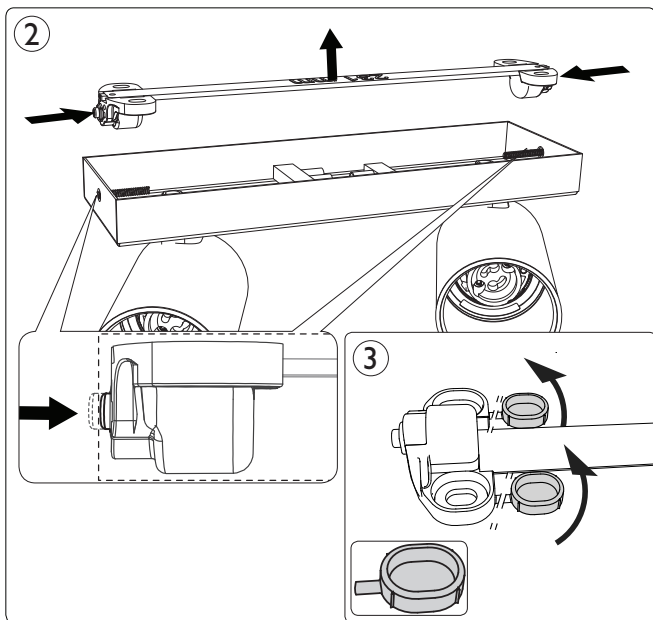
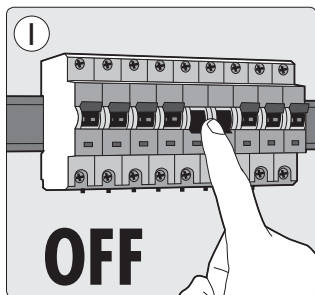

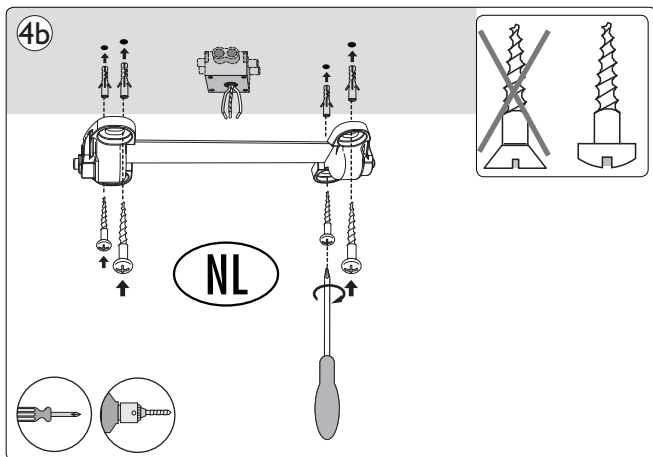
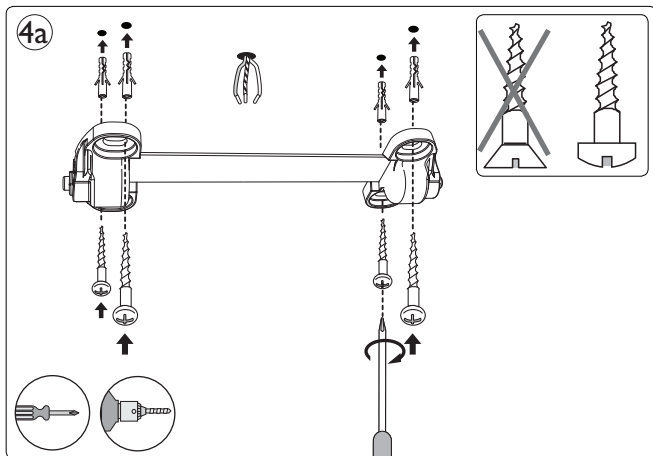

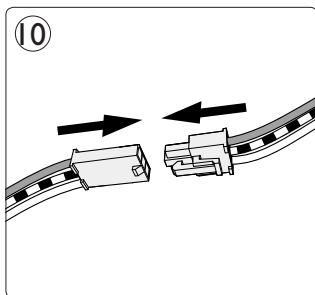
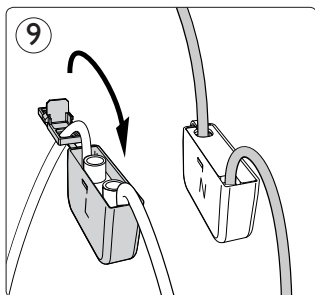
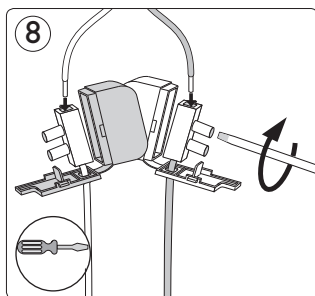
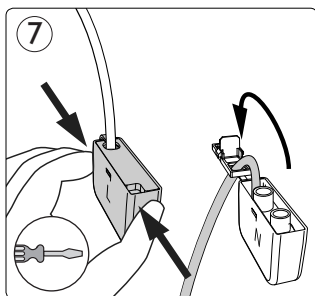
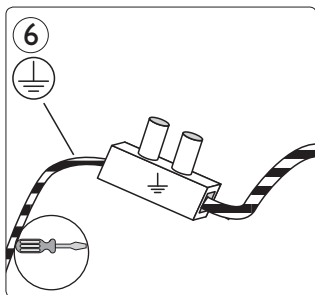
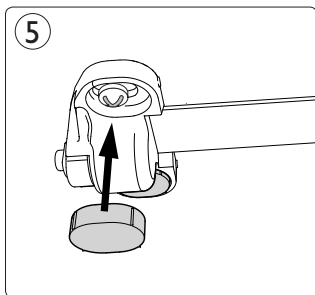

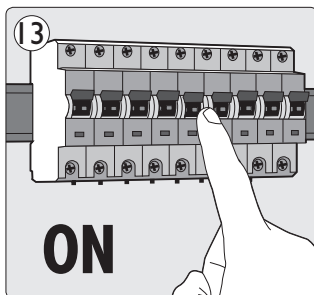
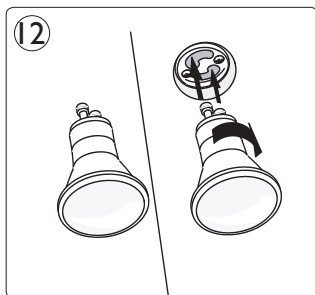
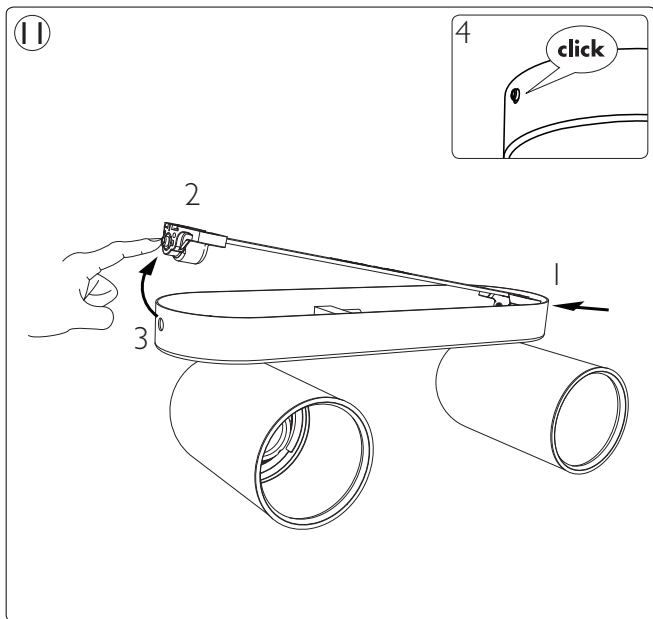

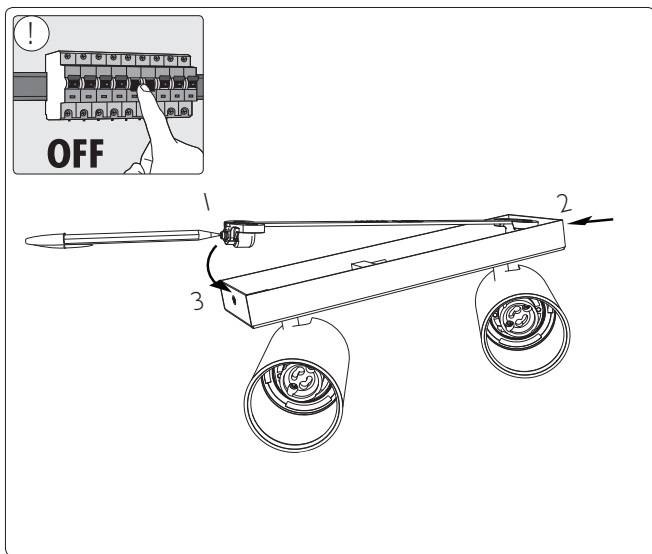
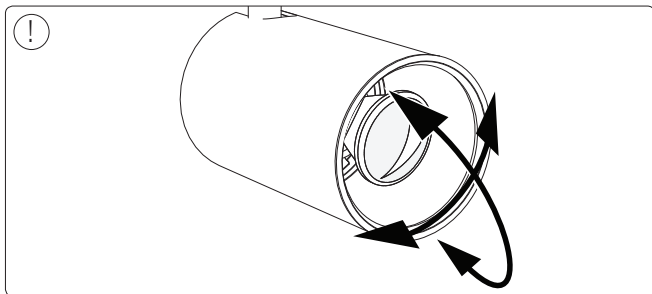





Philips Lighting Contact Centre
Int. Business Reply Service
I.B.R.S. / C.C.R.I. Numéro 10461
5600 VB Eindhoven
Pays-Bas / The Netherlands

www.philips.com
 +800 7445 4775

4404.029.07971
Last update: 31/05/17