

Gebruiksaanwijzing  
Notice d'emploi  
Benutzerhandbuch  
User manual  
Manual de usuario

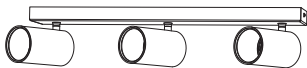

50592/\*\*/P0



50593/\*\*/P0



50591/\*\*/P0

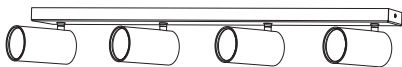

50594/\*\*/P0

# PHILIPS

Incl.

**A**



50592/\*\*/P0

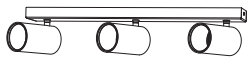

50593/\*\*/P0

**B**



50591/\*\*/P0

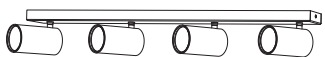

50594/\*\*/P0

Excl.

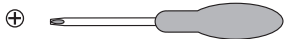
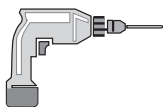

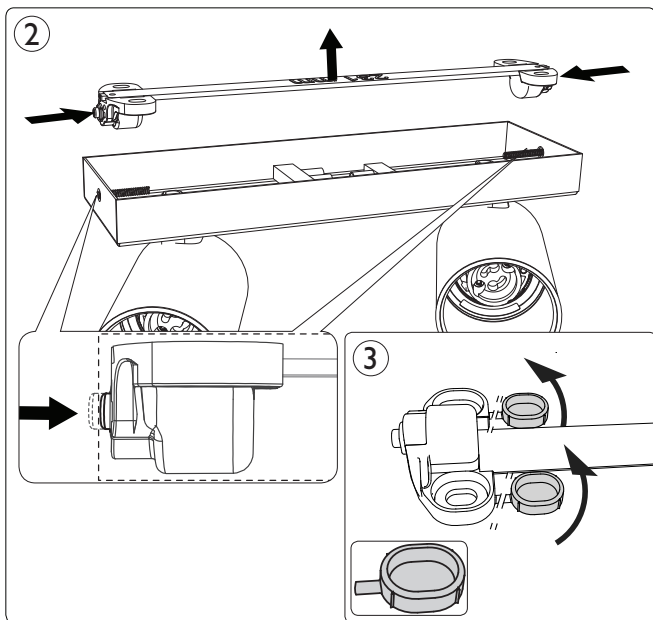
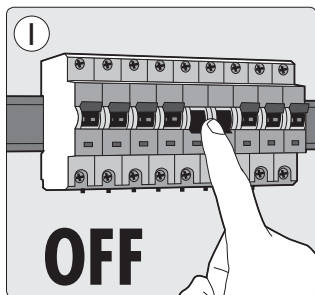

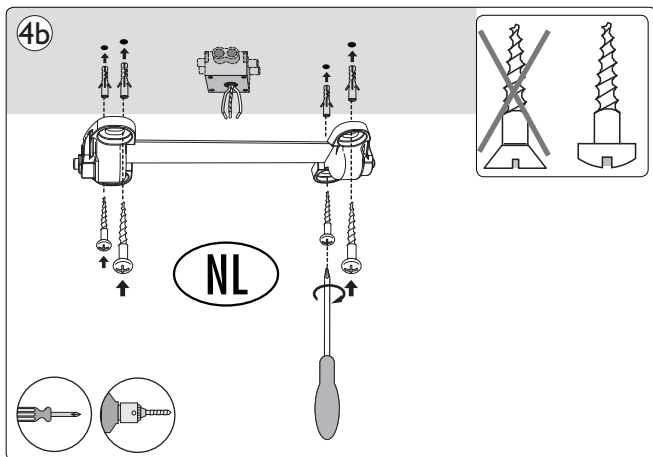
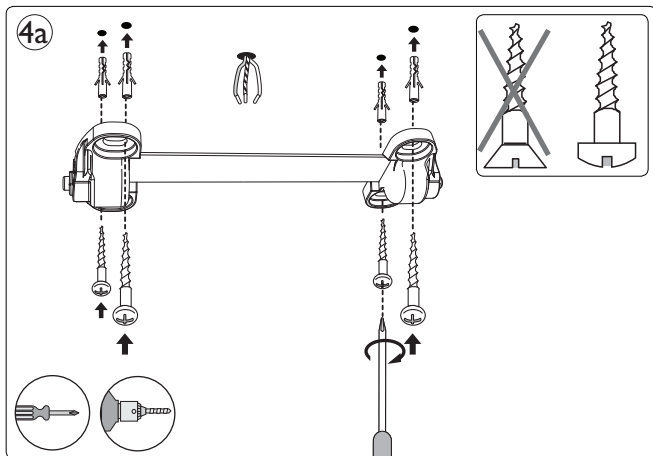

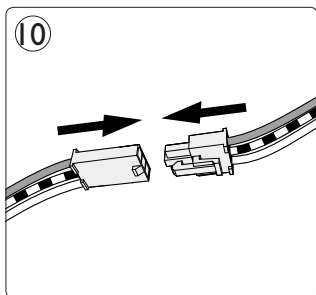
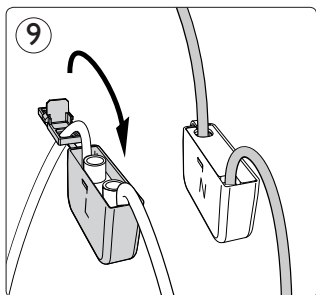
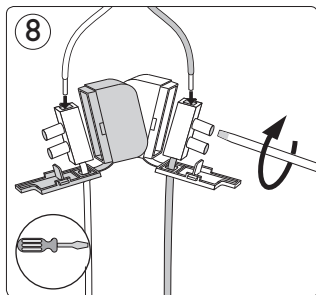
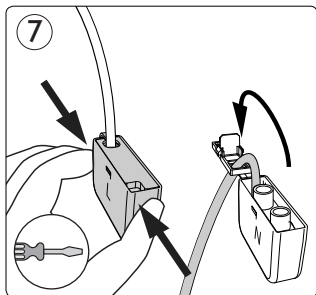
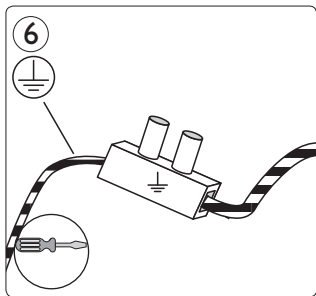
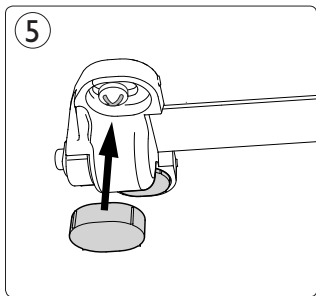

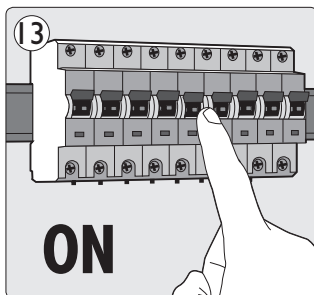
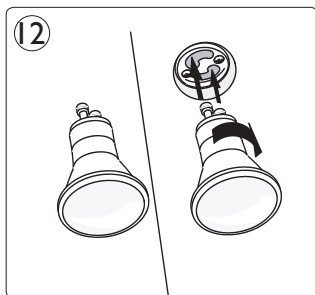
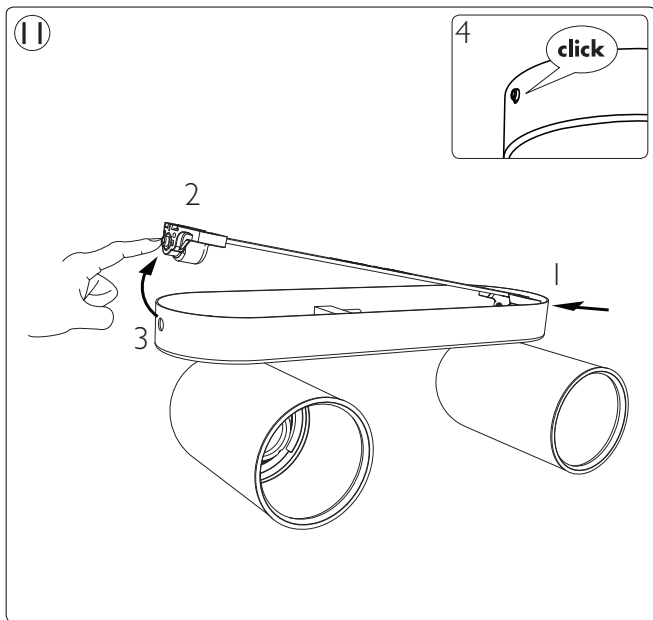

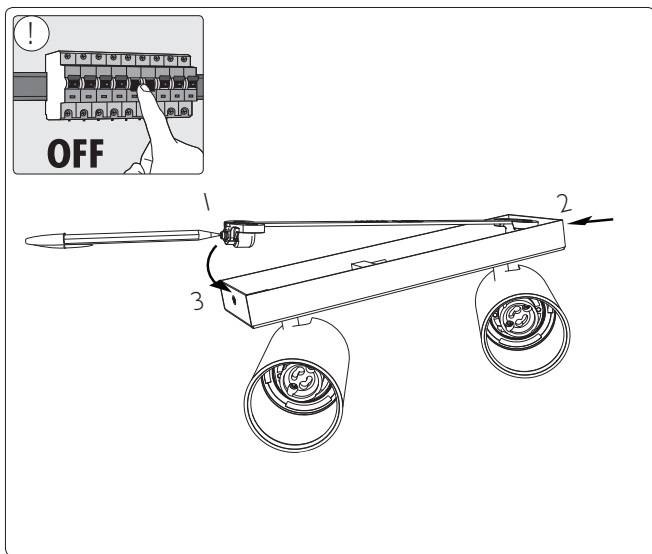
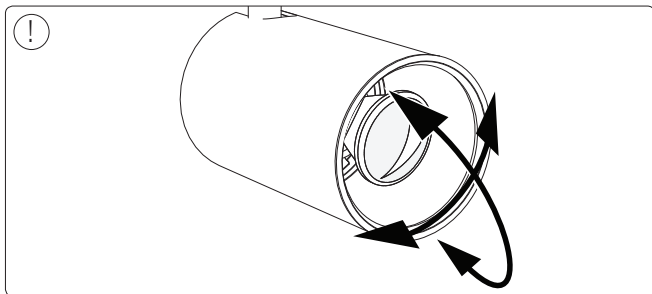





Philips Lighting Contact Centre  
Int. Business Reply Service  
I.B.R.S. / C.C.R.I. Numéro 10461  
5600 VB Eindhoven  
Pays-Bas / The Netherlands

[www.philips.com](http://www.philips.com)  
 +800 7445 4775

4404.029.07971  
Last update: 31/05/17